

Site Planning Guide

Siemens Mobile PET/CT System 48' L x 8'-6" W x 13'-6" H USA Unit

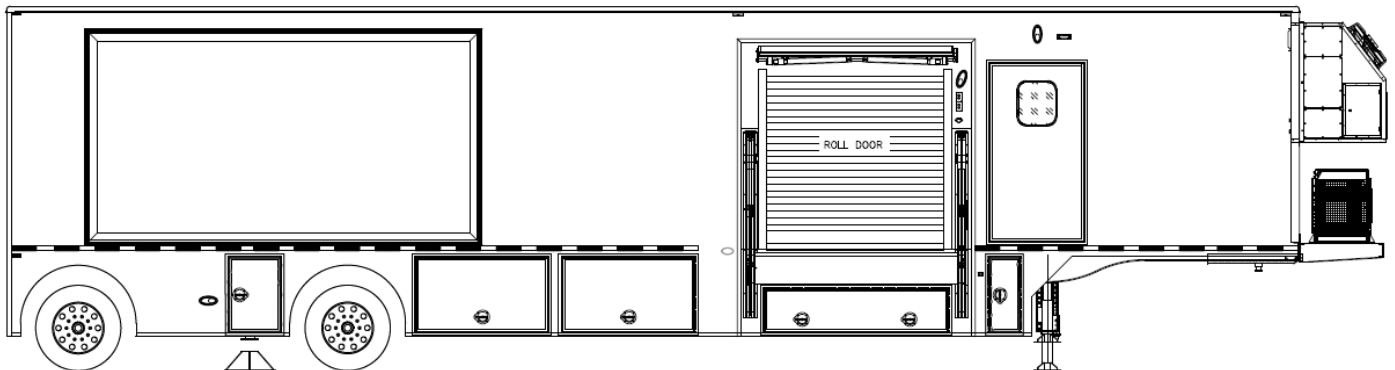

© 2021 AMST, All Rights Reserved

This manual contains confidential information of AMST.

This manual may be used only by you, and only for the purposes for which it was intended. You may not disclose this manual or the confidential information it contains outside of your company.

If you wish to copy any part of this manual, or to use it other than as described above, you must contact AMST seeking permission to do so.

You may not copy it or any part of it without the written permission of AMST

List of Revisions

Revisions

Date	Revision Number	Revised by	Description
12/10/2021	00	Chirag Patel	Initial Release

Notice

In accordance with our policy of product development, AMST reserves the right to make changes in the equipment, design, specifications, and materials of the product described herein. If there are any inconsistencies between this manual and the mobile unit that inhibit serviceability, please contact AMST for assistance.

This manual is provided in the mobile unit. The documentation package should be kept in the mobile unit at all times.

Any problems or questions related to the components or systems covered in this manual please direct to:

AMST

611 Commerce Center Drive
University Park IL.60484
708-235-2800
708-235-2002 FAX

<http://www.amstcorp.com>

Table of Contents

Introduction 6

Warnings & Safety Alert Conventions	6
<u>Support and Service Pad Requirements</u>	<u>7</u>
Recommended Support and Service Pad Requirements	7
Pad Depth.....	7
Pad Levelness	7
Electro Magnetic Interference	7
Vehicle Access	7
Recommended Attachment to the Facility.....	7
Swing Clearance Note.....	7
<u>Radiation Shielding Requirements</u>	<u>8</u>
Radiation Shielding.....	8
Radiation Field Information	8
<u>Customer Power Requirements</u>	<u>8</u>
Lockout/Tagout.....	8
Electrical Service	8
Configuration	8
Load Regulation at Line Frequency	9
Frequency.....	9
Phase Balance	9
Maximum Voltage Variation	9
Connector Type	9
Customer Facility.....	9
Input Power	9
Power Source Monitoring (Facility Only).....	9
<u>Mobile Grounding Requirements</u>	<u>10</u>
Special Ground Note	10
<u>Telephone and Data Service Requirements</u>	<u>10</u>
Telephone Service.....	10
Data Service	10



AMST
611 Commerce Center Drive
University Park, IL 60484
(708) 235-2800 main number
(708) 235-2002 fax

Custom Specialty Solutions

An ISO9001:2015 Certified Company

SPC-D20-00
Page 4 of 19

Water Requirements..... 10

Water Supply Tank 11

Portable Sink (optional) 11

Table of Figures

Figure 1: Plan Layout.....	12
Figure 2: Right Side Elevation	13
Figure 3: Left Side Elevation.....	14
Figure 4: Radiation Shielding Plan View.....	15
Figure 5: Stair / Lift / Wall Elevation.....	16
Figure 6: Russellstoll Receptacle, Service Disconnect.....	17
Figure 7: Russellstoll Receptacle Chart.....	18
Figure 8: Turning Requirements	19

Introduction

The purpose of this document is to provide the basic information needed for site planning. For specific information not contained in this document, please contact AMST.

The mobile unit requires sufficient room to be maneuvered and positioned for setup and takedown. The mobile unit has many storage compartments and service doors that require access during these procedures as well as during operation. The expanding wall sections, patient lift, entry stairs, and optional platform require additional space on the right side of the mobile unit. Refer to the drawings provided for actual locations of doors, patient lift, and stair sizes and locations.

Warnings & Safety Alert Conventions

Three types of statements are used throughout this document to warn the operator of potential situations. Always read these statements carefully and take the appropriate safety precautions to ensure a safe environment for all personnel and all property. The statements are as follows:



This type of notice indicates a potentially hazardous situation, which if not avoided, could result in injury or death to the operator of the mobile unit.



This type of notice indicates a potentially hazardous situation, which if not avoided, could result in irreparable damage to the mobile unit.



This type of notice is meant to inform the operator of useful information.

Support and Service Pad Requirements

IMPORTANT

If other modalities utilize the same support pad, it is recommended that non-ferrous reinforcement materials be used for pad reinforcement.

IMPORTANT

Siemens must approve plans for pad construction.

The following is a list of recommendations and requirements for a concrete support and service pad. However, due to varying site conditions, the actual pad design should be prepared by an appropriately licensed structural or architectural engineer.

Recommended Support and Service Pad Requirements

The measurements for the recommended support and service pads are in [Figure 1: Plan Layout](#)

Pad Depth

Pad Levelness

In order to ensure proper operation of the PET/CT system, the support pad(s) must be level and the set-up deviation must not exceed .125" in 10'-0.

The ambient static magnetic field within the region of the gantry should not exceed 1 Gauss (10^{-4} Tesla) peak at the detector.

Vehicle Access

A firm, level surface is required around the mobile unit in order to provide access to the site, patient access to the mobile unit, and servicing of the mobile unit.

Recommended Attachment to the Facility

An inflatable air bag or soft seal is recommended at the point of connection from the unit to the facility. Fixed or solid connections may hinder imaging quality. Contact AMST or the local Siemens representative prior to construction if the proposed connection varies from the recommended.

Swing Clearance Note

Please verify the actual dimensions of the rearmost projections on the cab of your tractor to the centerline of tandem suspension or centerline of the fifth wheel plate on your tractor. Refer to [Figure 8: Turning Requirements](#) for proper tractor sizing information.

Radiation Shielding Requirements

Radiation Shielding

IMPORTANT

Radiation exposure limits must be in accordance with all local, state, and federal requirements. It is the responsibility of the customer to perform a proper radiation survey in order to determine the exclusion zone.

Care should be taken when determining a site location. Factors such as shielding design, proximity to buildings, and occupancy of the surrounding areas must be considered. An exclusion zone around the mobile unit may be necessary. Refer to

[Figure 4: Radiation Shielding Plan](#) View for additional information.

Radiation Field Information

It is the responsibility of the customer to ensure a safe environment with respect to the radiation field. Due to radioactivity levels associated with patient handling and diagnostic procedures used in PET/CT scanning, an exclusion zone must be maintained while in use.

Customer must contact their local Radiation Safety Operation Official for the federal, state, and local guidelines and must comply with these safety requirements.

Operator needs to make their own exposure dose measurements to include radiation from patients when determining the outside "Keep Away Zone" (chained-off area).

Customer Power Requirements



It is the operator's responsibility to verify that the shore power receptacle is of the same type and voltage as the connection that is supplied by AMST. Failure to do this can result in injury or death to the operator of the mobile unit as well as irreparable damage to the mobile unit.



The standard connector for the unit is a Russellstoll DS2504MP 480V 200A Plug. If an existing site currently implements a different connector or connector configuration, please contact AMST in order to arrange for a compatible power connector before the unit leaves the facility.

Lockout/Tagout

A Lockout/Tagout provision in accordance with OSHA Standard 1910.147 is required. The facility shore power disconnect device must be located within 40'- 0" of the unit and must provide for an effective lockout/tagout to facilitate safe service and maintenance of the unit.

Electrical Service

Manufacturer	System	Power	Phase	Amps	Neutral Required	Connection Type
Siemens	Horizon	480	3 Phase	150	Yes	5 Wire Wye
	mCT	480	3 Phase	150	Yes	5 Wire Wye

Configuration

The connector is wired for three phase, five wire, Wye connection, with ground/neutral dependent on system (not less than AWG #1/0).

Load Regulation at Line Frequency

Wires are to be sized such that the line voltage drops from the power source to the mobile unit is less than 2.5% of the nominal voltage for the rated load of the mobile unit.

Frequency

60Hz \pm 2.0Hz.

Phase Balance

The phase balance is 3% maximum of lowest phase-to-phase voltage.

Maximum Voltage Variation

The maximum voltage variation is +11% / -4% from a nominal steady state (under the worst case conditions of line voltage).

Connector Type

The mobile unit is supplied with a 50'-0" power cable and male conductor. Unless otherwise specified, the connector type is a Russellstoll DS2504MP000/DF2504FRAB0 480V 200A rated plug.

Customer Facility

The customer facility must have the matching receptacle as specified in [Figure 6: Russellstoll Receptacle, Service Disconnect](#) and [Figure 7: Russellstoll Receptacle Chart](#). Unless otherwise specified, the receptacle type to be used must be a Russellstoll DF2504FRAB0 female connector.

Input Power

- Frequency: 60Hz \pm 2.0Hz
- Regulation: Load regulation must not exceed 2.5%.
- Phase Imbalance: The difference between the highest line-to-line voltage and lowest line-to-line voltage must not exceed 3% of the lowest line-to-line voltage.

Power Source Monitoring (Facility Only)

NOTE: Perform a power audit first.

A power analyzer should be used to check the proposed Mobile facility site power for average line voltage, surges, sags, reclosures, impulses, frequency and microcuts. A period that includes two weekends should be used to simulate several days of normal use. Analysis of the data and site history of any previous power problems with other X-ray systems or computer installations should be reviewed with your power and ground representative. Verify “brown-out” (low voltage) conditions, which may occur during summer months, will not exceed the allowable range.

Some analyzer models that are suitable for power monitoring are:

- Dranetz Model 658
- Dranetz Model 656A
- BMI 3630
- RPM

Mobile Grounding Requirements

Special Ground Note

It is recommended that the unit have an earth driven ground rod within five (5) feet of the facility power receptacle. A grounding cable of a minimum of #3/0 AWG is recommended to be connected between the grounding rod and the grounding pin of the facility power receptacle. Another cable to be kept as short as possible may also be connected between the ground stud on the Incoming Power Distribution Panel and an earth driven ground rod. A separate grounding conductor is highly recommended to be ran with the phase conductors to the source of power from the grounding pin of the facility power receptacle in accordance with NEC 2017 Article 250-24.

Telephone and Data Service Requirements

Telephone Service

The mobile unit is supplied with two (2) telephone connections. The connector type that is used is a Hubbell model PH-6595 (inlet) with a model PH-6624 connector body.

The customer is required to purchase and install two (2) Hubbell all weather telephone connections, model PH-6597 for use at the site.

Two Hubbell model PH-6599 telephone-connecting cables are included with the mobile unit. The cables measure 50'-0" in length.

Data Service

The mobile unit is supplied with six (6) data line connections that utilize RJ-45 outlets.

The customer is required to purchase the data connection cables for use with the data line connections. The data line connections require a 50'-0" CAT-6E cable with RJ-45 connections.

Water Requirements

IMPORTANT

winter conditions, provisions must be made to ensure that water lines do not because of weather conditions.

Water Supply Tank

A 35-gallon water supply tank is located on the right side of the mobile unit in the underbody compartments, which supplies the HVAC system.

The water supply tank can be filled from within the compartment by using the supplied adapter or from the exterior of the mobile unit by using the connection on the underbody compartment door and the supplied hose.

The drain for the water supply tank is located below the underbody compartment door. The drain valve is located in the underbody compartment.

Portable Sink (optional)

An optional portable self-contained sink is available. Within the portable sink assembly is the water supply and wastewater tank.

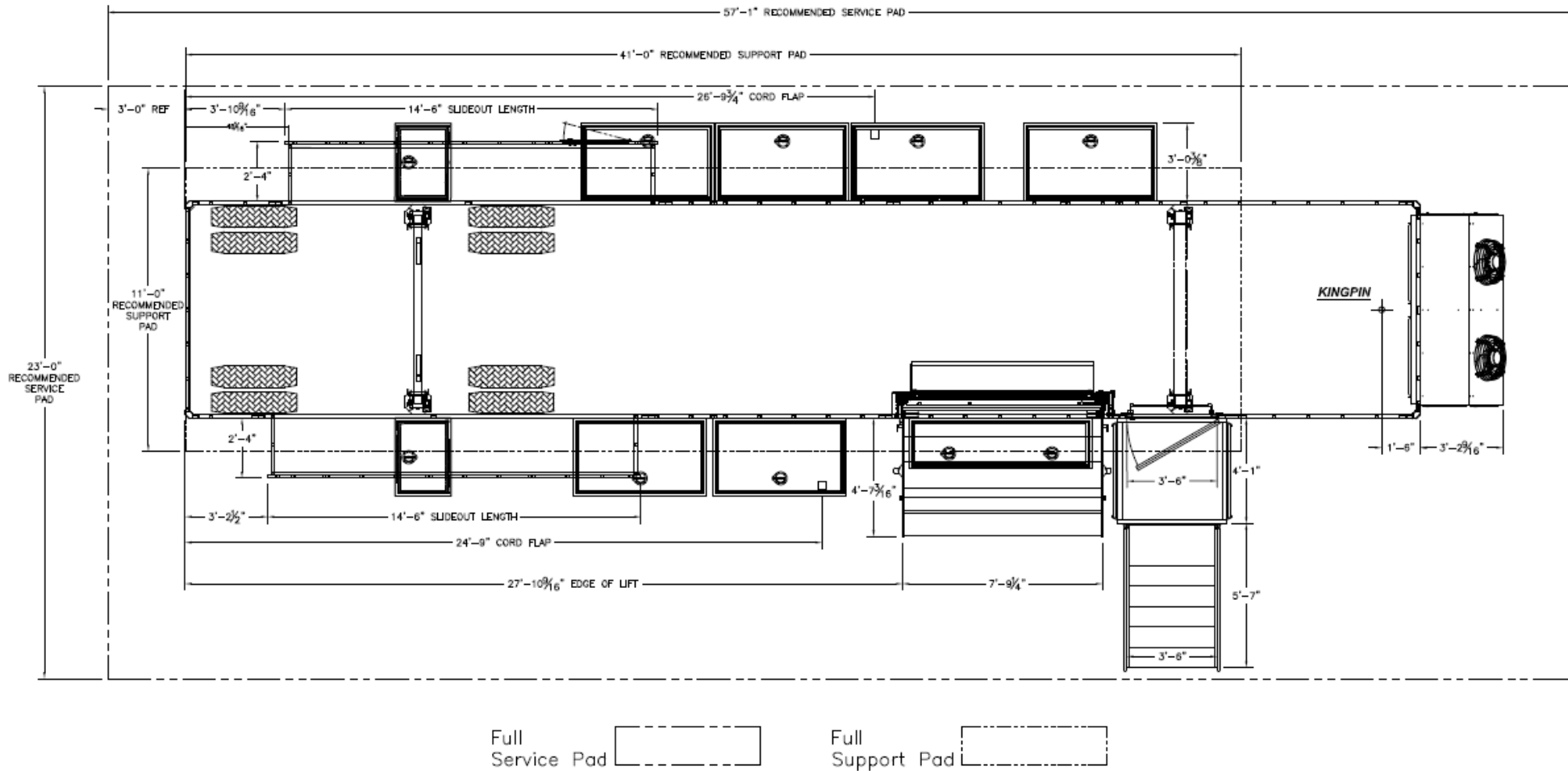

Figure 1: Plan Layout

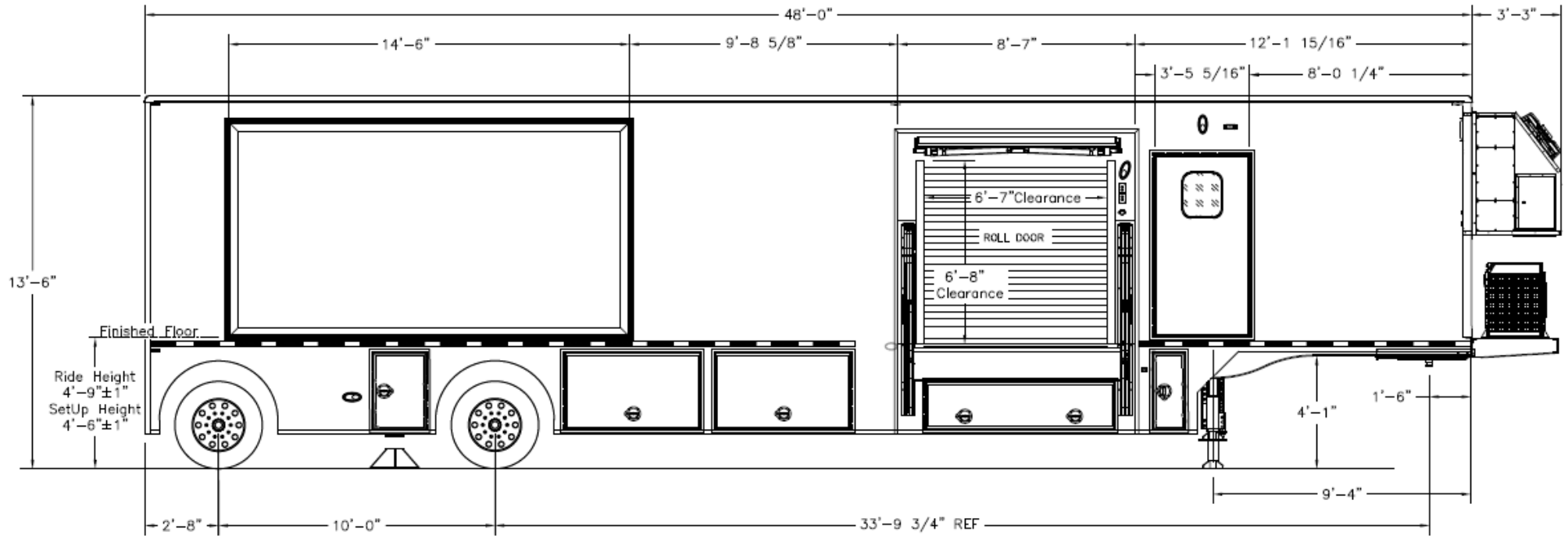

Figure 2: Right Side Elevation

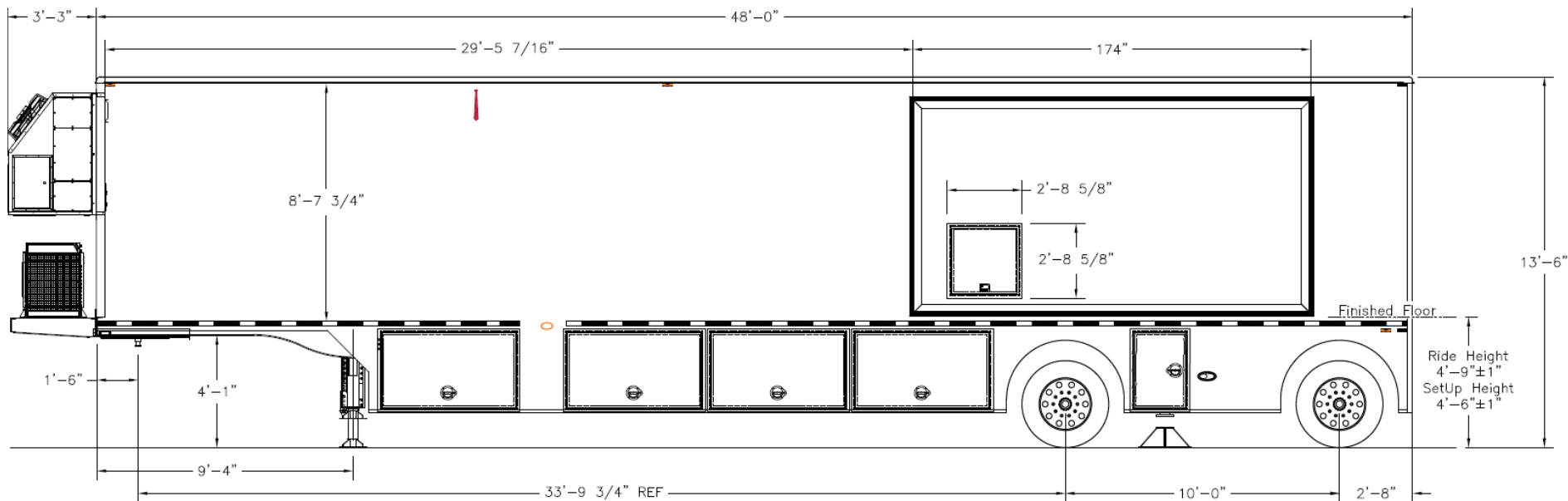

Figure 3: Left Side Elevation

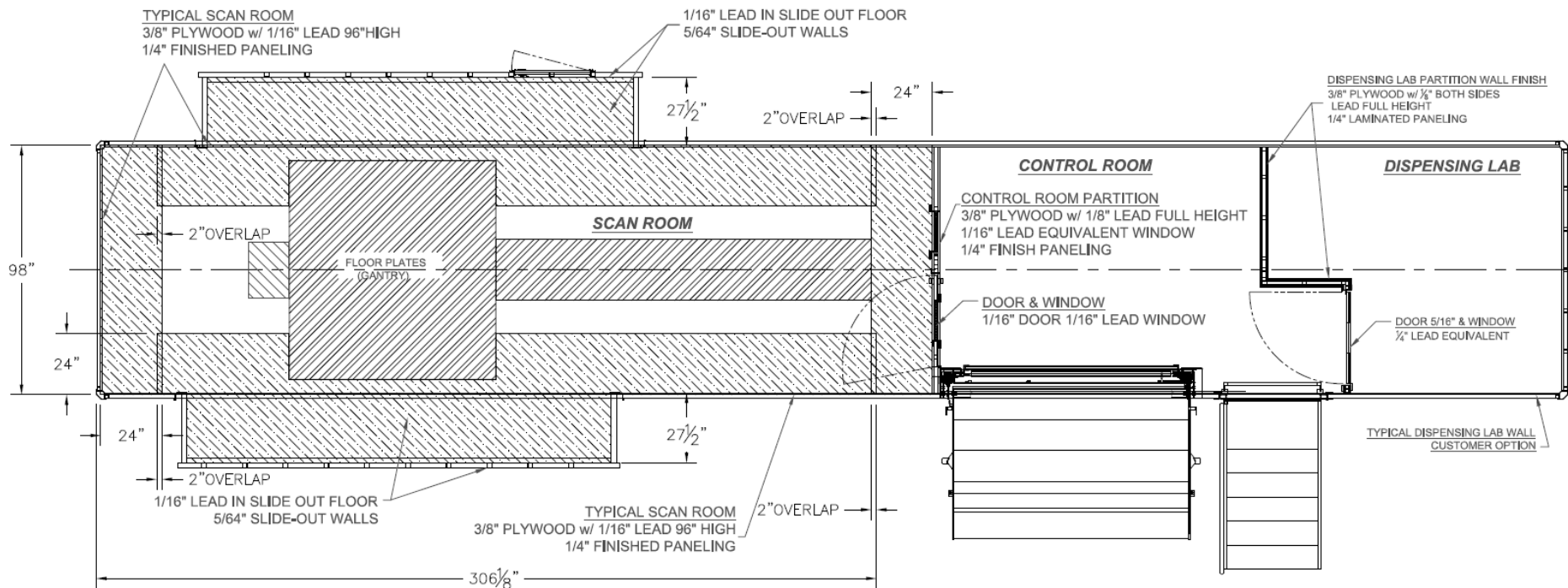

Figure 4: Radiation Shielding Plan View

NOTE:

ALL WALLS IN SCAN ROOM SECTIONS TO BE 1/16" LEAD LINED

ALL EXPANDING WALLS 5/64" LEAD

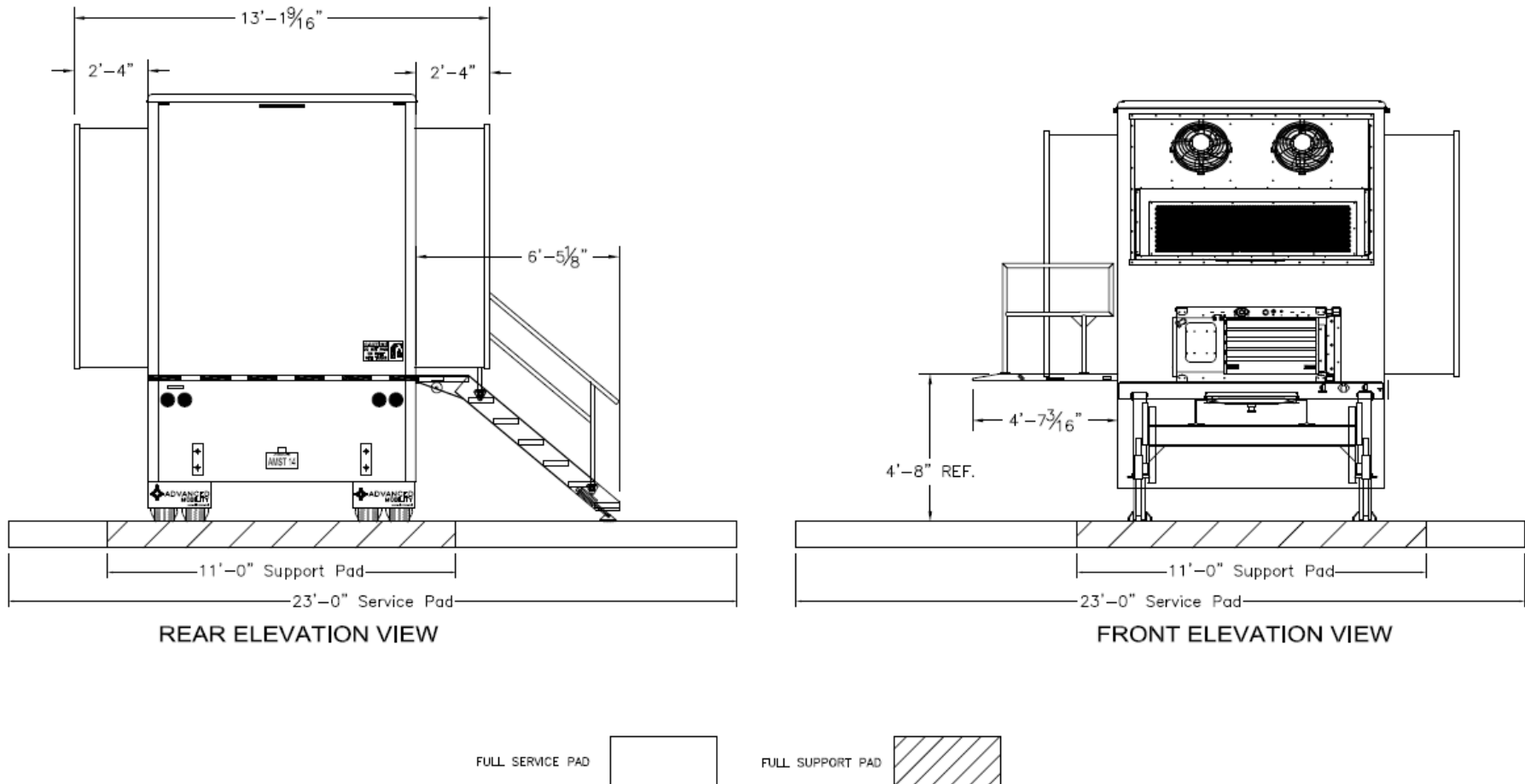

Figure 5: Stair / Lift / Wall Elevation

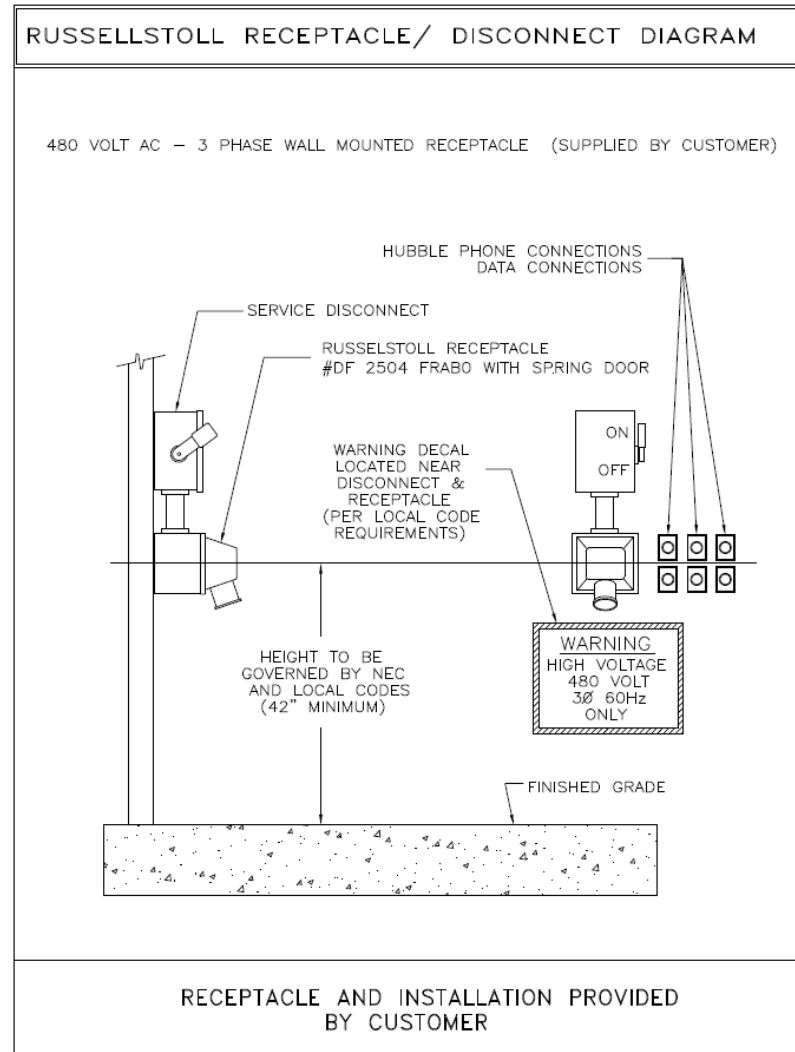

Figure 6: Russellstoll Receptacle, Service Disconnect

RUSSELLSTOLL RECEPTACLE CHART			
AMP / WIRE	DESCRIPTION		RECEPTACLE
	WIRES	POLES	PART NUMBER
MAXIMUM WIRE SIZE FOR LUG # 3/0	5	4	480 VOLT (150 AMP) 5 WIRE RUSSELLSTOLL RECEPTACLE DF 2504 FRABO THIS RECEPTACLE MUST BE WATERPROOF
480 VOLT AC DEDICATED POWER LINE FROM MAIN TRANSFORMER STATION	3Ø	WYE CONNECTION 150 AMP TOTAL 3Ø NEUTRAL AND GROUND	
RUSSELLSTOLL MATING PLUG PART# DS2504MP000/DF2034 5 WIRE/4 POLE		MAIN DISCONNECT 3/N/PE AC 480 VOLT 150 AMP FUSED DISCONNECT	
			
RECEPTACLE AND INSTALLATION PROVIDED BY CUSTOMER			

Figure 7: Russellstoll Receptacle Chart

NOTE: The Neutral wire shown in the Shore Power receptacle may be required for certain units. The power Plug does have a Neutral wire terminal if the unit requires it.

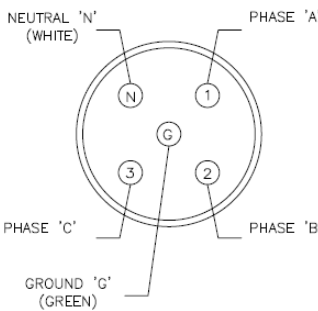
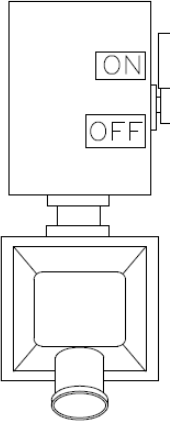
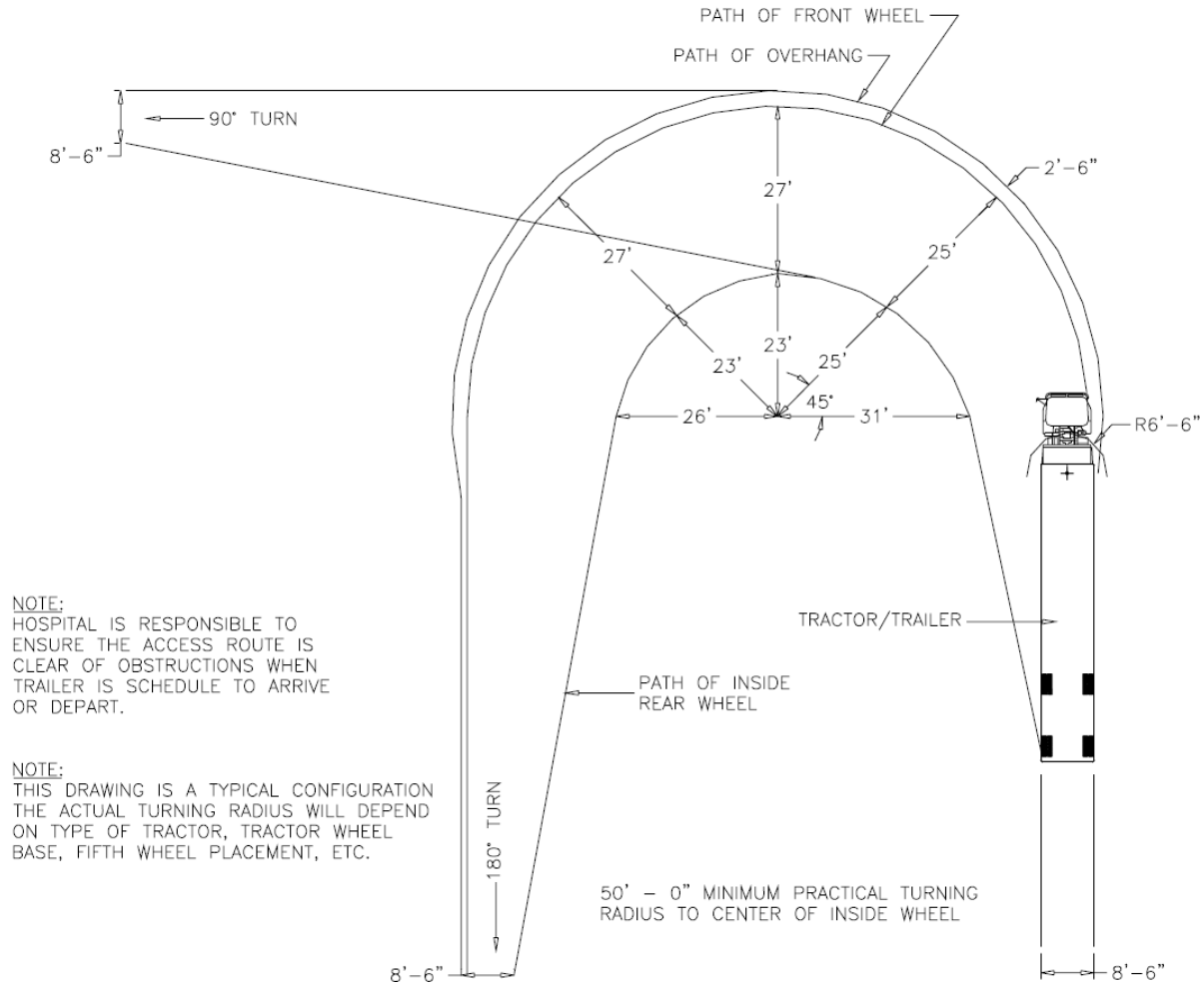

Figure 8: Turning Requirements